

GENERAL NOTES:

1. CALL BC ONE-CALL 24 HOURS PRIOR TO CONSTRUCTION.
2. UTILITY TRENCH WIDTH VARIES WITH DIAMETER AND DEPTH OF UTILITY PIPE TO BE INSTALLED. MINIMUM WIDTH TYPICALLY 600mm.
3. THESE DRAWINGS TO BE READ IN CONJUNCTION WITH OTHER CIVIL AND OTHER DISCIPLINE'S DRAWINGS.

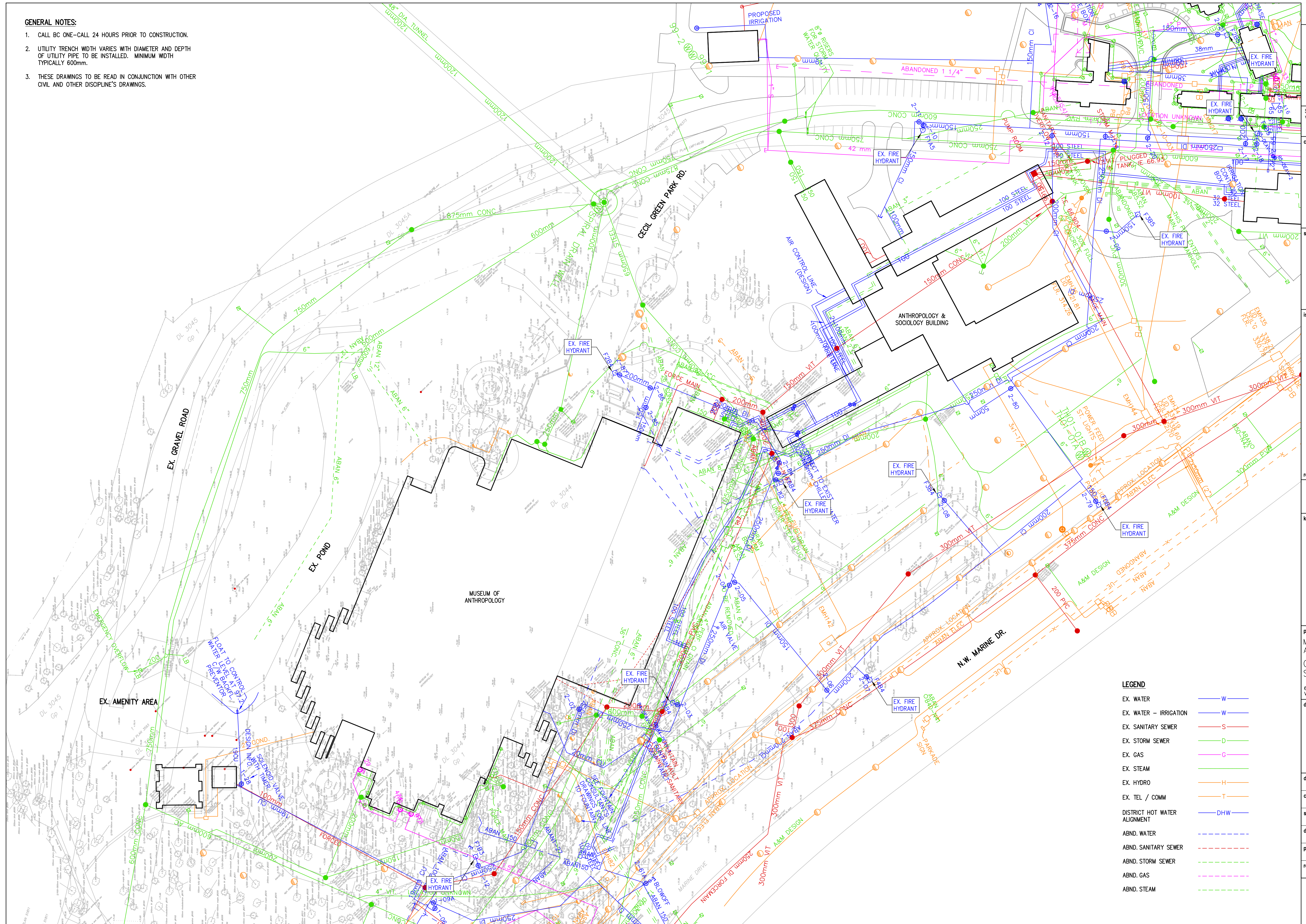

LEGEND

- EX. WATER — W —
- EX. WATER - IRRIGATION — W —
- EX. SANITARY SEWER — S —
- EX. STORM SEWER — D —
- EX. GAS — G —
- EX. STEAM — S —
- EX. HYDRO — H —
- EX. TEL / COMM — T —
- DISTRICT HOT WATER ALIGNMENT — DHW —
- ABND. WATER — - - - - -
- ABND. SANITARY SEWER — - - - - -
- ABND. STORM SEWER — - - - - -
- ABND. GAS — - - - - -
- ABND. STEAM — - - - - -

Suite 303, 375 West 5th Avenue tel: 604.737.6061
 Vancouver, BC, Canada V5Y 1J6 fax: 604.737.6091
 e-mail: rna@milkovicharchitects.com
 web: www.milkovicharchitects.com

consultant

CoreGroup
 CONSULTANTS
 LAND DEVELOPMENT SERVICES
 320-8888 FRASERTON COURT
 BURNABY, BC V5B 5H8
 tel: (604)299-0605 fax: (604)299-0629

ISSUED FOR DEVELOPMENT PERMIT
 2019/10/10

revisions

© Copyright reserved. This plan and design is and all times remains the exclusive property of Nick Milovich Architects Inc. and cannot be used without the architect's consent.
 All measurements must be checked on the drawings by the contractor.
 This drawing is not to be used for construction purposes unless countersigned.

key plan

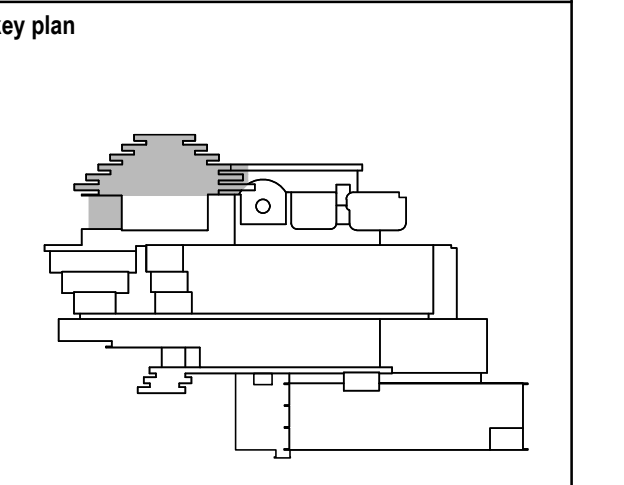

project title
**MUSEUM OF ANTHROPOLOGY
 GREAT HALL
 SEISMIC UPGRADE TP 1**
 6393 N.W. MARINE DRIVE
 VANCOUVER, B.C.

drawing title
**UBC MUSEUM OF ANTHROPOLOGY
 EXISTING SERVICES**

drawn	BC	north arrow	
checked	CN		
scale	1 : 500		
drawing date	2019/10/10	printed	2019/10/10
project no.		drawing no.	1 of 5
rev.			

LEGEND

EX. WATER	
EX. WATER - IRRIGATION	
EX. SANITARY SEWER	
EX. STORM SEWER	
EX. GAS	
EX. STEAM	
EX. HYDRO	
EX. TEL / COMM	
DISTRICT HOT WATER ALIGNMENT	
ABND. WATER	
ABND. SANITARY SEWER	
ABND. STORM SEWER	
ABND. GAS	
ABND. STEAM	

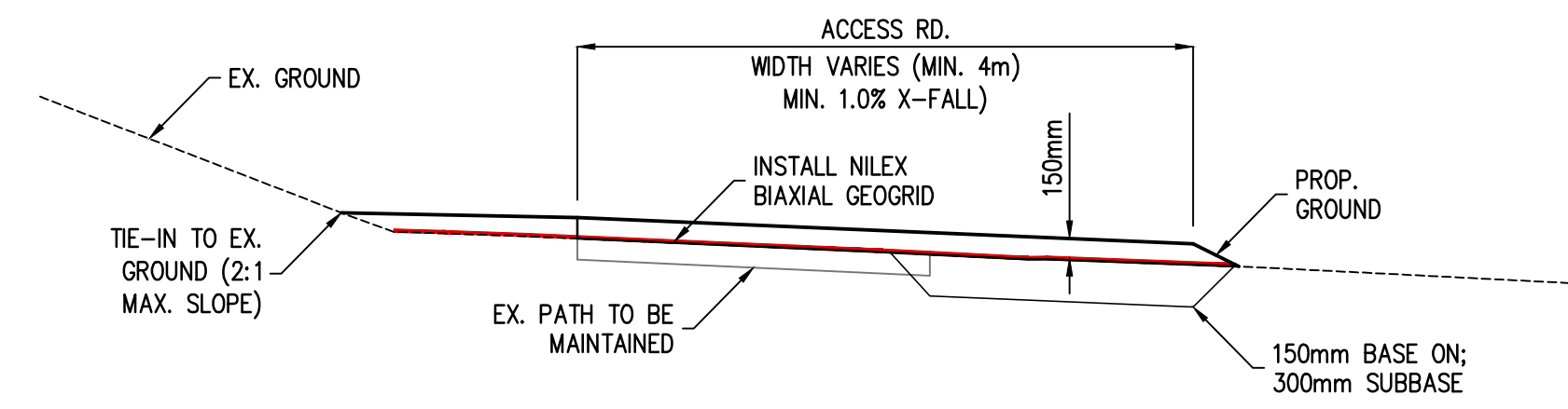
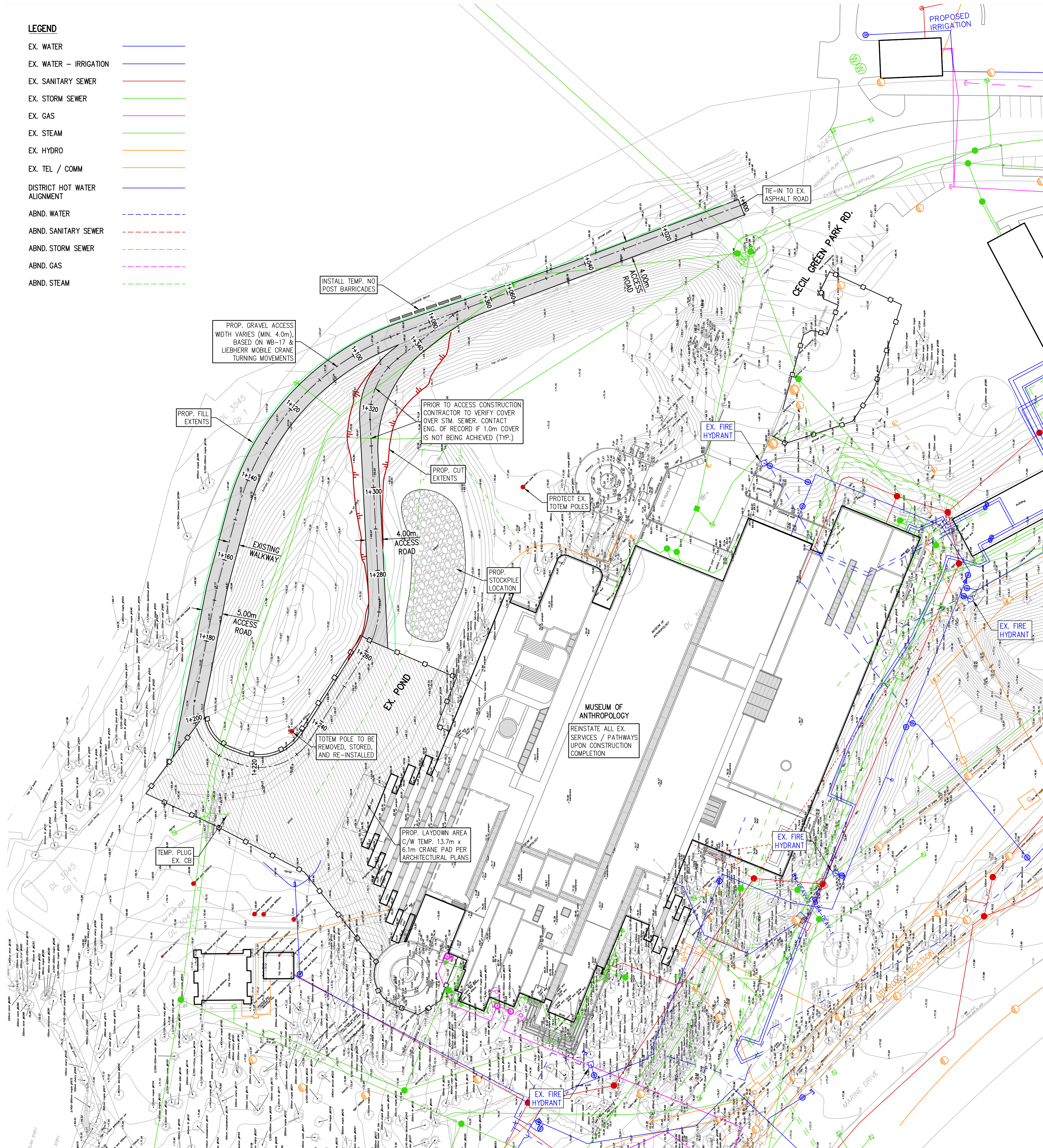

CRANE ACCESS ROAD TYPICAL SECTION

SCALE 1:50

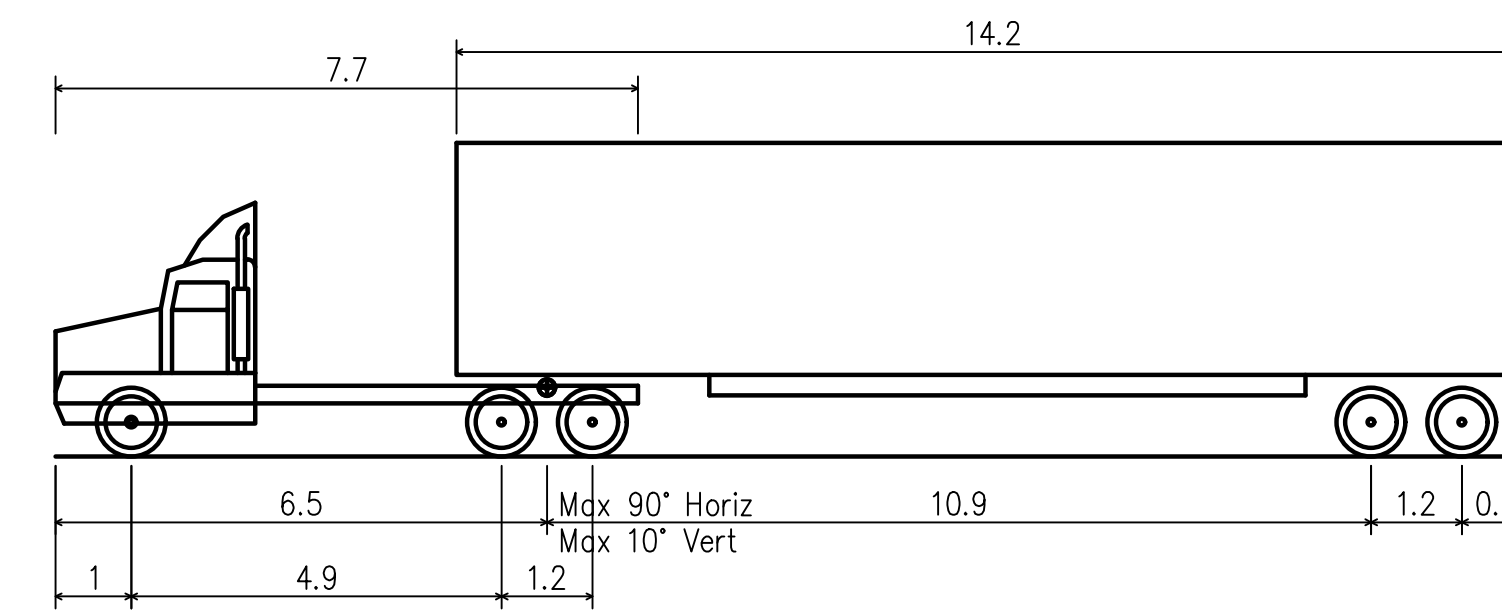

WB-17 - Semitrailer Combination
 Overall Length 19.500m
 Overall Width 2.600m
 Overall Body Height 4.150m
 Min Body Ground Clearance 0.435m
 Track Width 2.600m
 Lock-to-lock time 4.00s
 Curb to Curb Turning Radius 14.600m

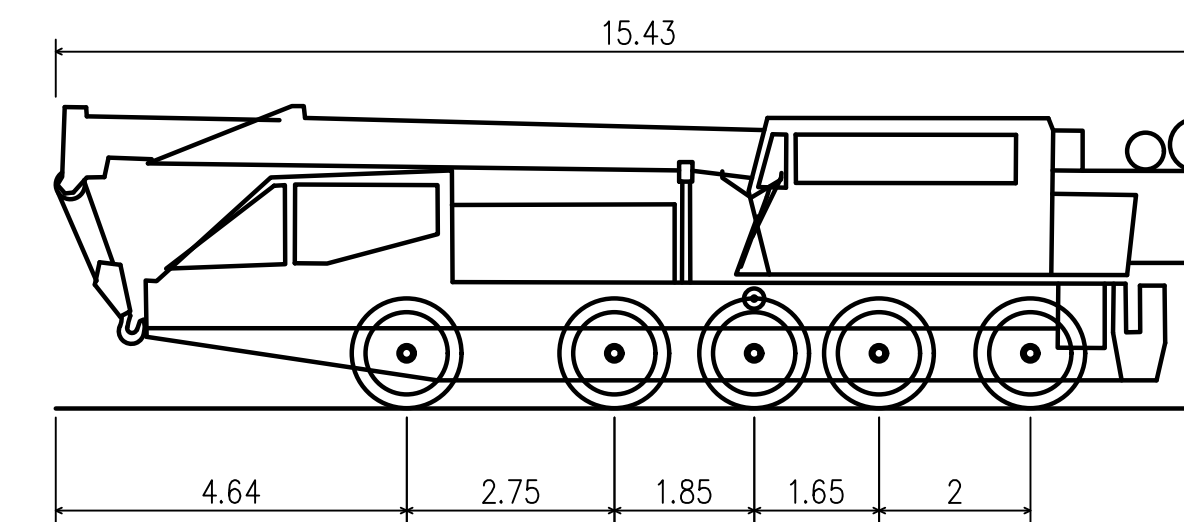

Liebherr LTM 1220-5.1 Mobile Crane
 Overall Length 15.430m
 Overall Width 3.230m
 Overall Body Height 4.000m
 Min Body Ground Clearance 0.370m
 Track Width 3.230m
 Lock-to-lock time 4.00s
 Curb to Curb Turning Radius 10.164m

GENERAL NOTES:

- CALL BC ONE-CALL 24 HOURS PRIOR TO CONSTRUCTION.
- UTILITY TRENCH WIDTH VARIES WITH DIAMETER AND DEPTH OF UTILITY PIPE TO BE INSTALLED. MINIMUM WIDTH TYPICALLY 600mm.
- THESE DRAWINGS TO BE READ IN CONJUNCTION WITH OTHER CIVIL AND OTHER DISCIPLINE'S DRAWINGS.
- ALL WORKS & MATERIALS TO BE IN ACCORDANCE WITH MMCD.

Suite 303, 375 West 5th Avenue tel: 604.737.6061
 Vancouver, BC, Canada V5Y 1J6 fax: 604.737.6091
 e-mail: rna@mikovicharchitects.com
 web: www.mikovicharchitects.com

consultant

CoreGroup
 CONSULTANTS
 LAND DEVELOPMENT SERVICES
 320-8888 FRASERTON COURT
 BURNABY, BC V5B 5H8
 tel: (604)299-0605 fax: (604)299-0629

seal

issued

ISSUED FOR DEVELOPMENT PERMIT
 2019/10/10

revisions

© Copyright reserved. This plan and design is and it all times remains the exclusive property of Mikovich Architects Inc. and cannot be used without the architect's consent.
 All measurements must be checked on the drawings by the contractor.
 This drawing is not to be used for construction purposes unless countersigned.

key plan

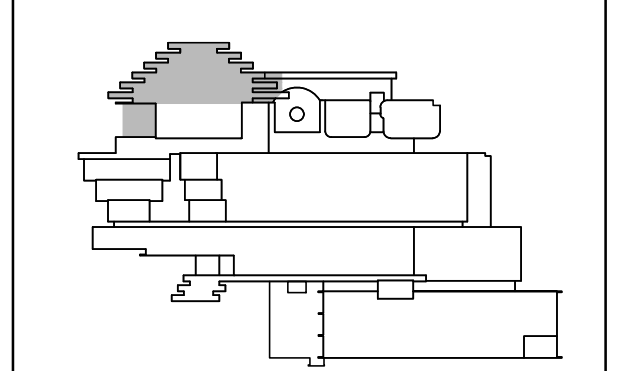

project title

MUSEUM OF ANTHROPOLOGY
GREAT HALL SEISMIC UPGRADE TP 1

6393 N.W. MARINE DRIVE
 VANCOUVER, B.C.

drawing title

UBC MUSEUM OF ANTHROPOLOGY
CONSTRUCTION ACCESS SITEPLAN

drawn	BC	north arrow	
checked	CN		
scale	1 : 500		
drawing date	2019/10/10	printed	2019/10/10
project no.		drawing no.	2 of 5
rev.			

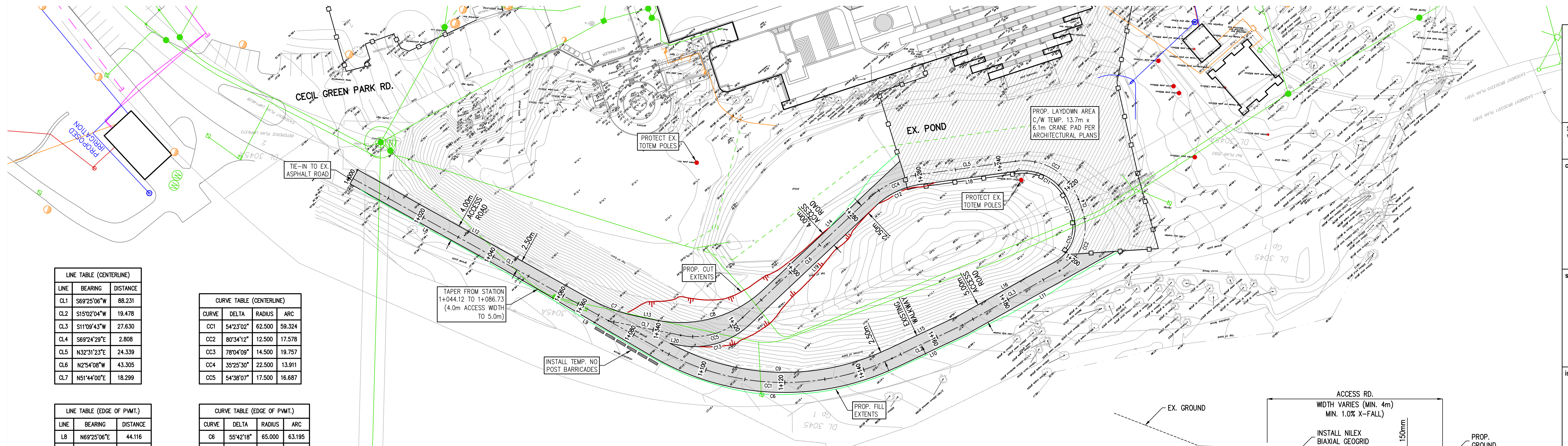

LINE	BEARING	DISTANCE
CL1	S69°25'06"W	88.231
CL2	S15°02'04"W	19.478
CL3	S11°09'43"W	27.630
CL4	S69°24'29"E	2.808
CL5	N32°31'23"E	24.339
CL6	N2°54'08"W	43.305
CL7	N51°44'00"E	18.299

CURVE	DELTA	RADIUS	ARC
CC1	54°23'02"	62,500	59,324
CC2	80°34'12"	12,500	17,578
CC3	78°04'09"	14,500	19,757
CC4	35°25'30"	22,500	13,911
CC5	54°38'07"	17,500	16,687

LINE	BEARING	DISTANCE
L8	N69°25'06"E	44.116
L9	N70°44'22"E	42.628
L10	N15°02'04"E	19.563
L11	N11°09'43"E	42.027
L12	S69°25'06"W	66.206
L13	S51°44'00"W	5.165
L14	S2°54'08"E	46.730
L15	S15°02'04"W	19.394
L16	S11°09'43"W	27.546
L17	S69°24'29"E	2.808
L18	N32°31'23"E	24.339
L19	N2°54'08"W	43.305
L20	N51°44'00"E	2.216

CURVE	DELTA	RADIUS	ARC
C6	55°42'18"	65,000	63,195
C7	17°41'06"	40,000	12,346
C8	54°38'07"	30,000	28,607
C9	53°44'44"	60,000	56,282
C10	80°34'12"	10,000	14,062
C11	78°04'09"	12,000	16,351
C12	35°25'30"	20,000	12,366
C13	54°38'07"	20,000	19,071

LEGEND

EX. WATER		DISTRICT HOT WATER ALIGNMENT	
EX. WATER - IRRIGATION		ABND. WATER	
EX. SANITARY SEWER		ABND. SANITARY SEWER	
EX. STORM SEWER		ABND. STORM SEWER	
EX. GAS		ABND. GAS	
EX. STEAM		ABND. STEAM	
EX. HYDRO		ABND. STEAM	
EX. TEL / COMM			

GENERAL NOTES:

- CALL BC ONE-CALL 24 HOURS PRIOR TO CONSTRUCTION.
- UTILITY TRENCH WIDTH VARIES WITH DIAMETER AND DEPTH OF UTILITY PIPE TO BE INSTALLED. MINIMUM WIDTH TYPICALLY 600mm.
- THESE DRAWINGS TO BE READ IN CONJUNCTION WITH OTHER CIVIL AND OTHER DISCIPLINE'S DRAWINGS.
- ALL WORKS & MATERIALS TO BE IN ACCORDANCE WITH MMCD.

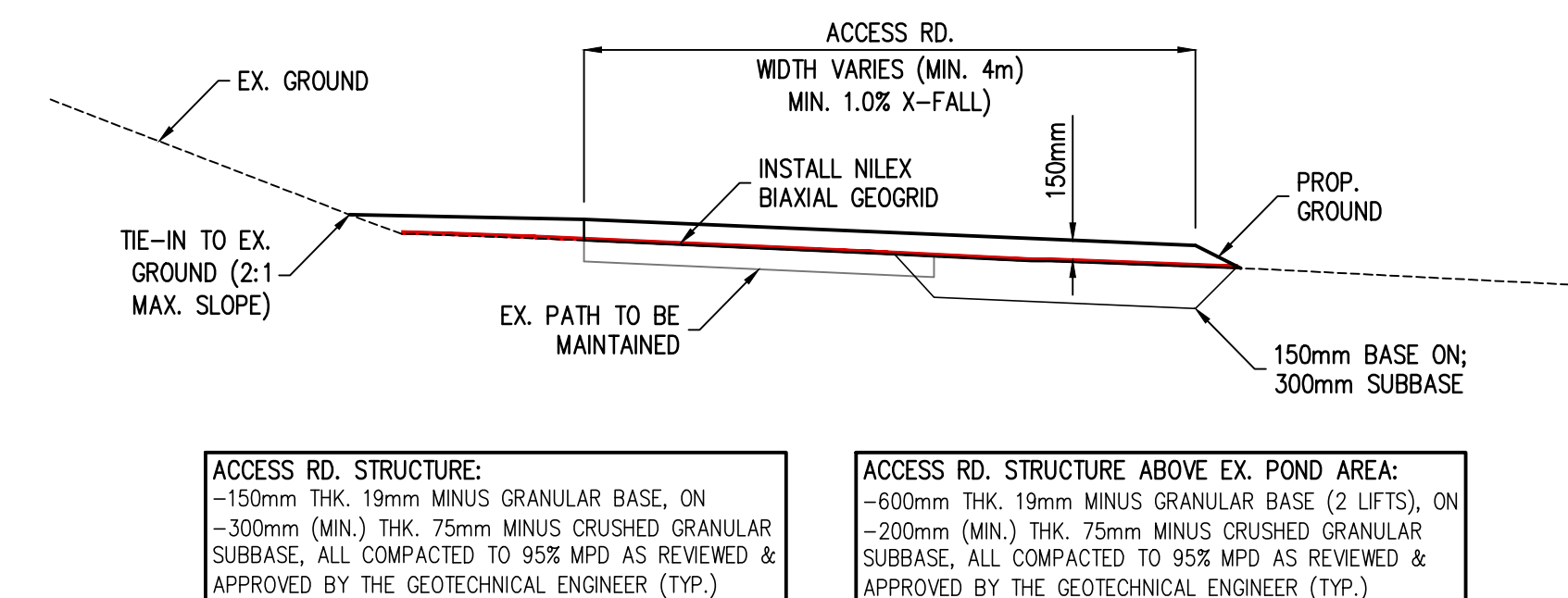

ACCESS RD. STRUCTURE:
 -150mm THK. 19mm MINUS GRANULAR BASE, ON
 -300mm (MIN.) THK. 75mm MINUS CRUSHED GRANULAR SUBBASE, ALL COMPACTED TO 95% MPD AS REVIEWED & APPROVED BY THE GEOTECHNICAL ENGINEER (TYP.)

ACCESS RD. STRUCTURE ABOVE EX. POND AREA:
 -600mm THK. 19mm MINUS GRANULAR BASE (2 LIFTS), ON
 -200mm (MIN.) THK. 75mm MINUS CRUSHED GRANULAR SUBBASE, ALL COMPACTED TO 95% MPD AS REVIEWED & APPROVED BY THE GEOTECHNICAL ENGINEER (TYP.)

CRANE ACCESS ROAD TYPICAL SECTION
SCALE 1:50

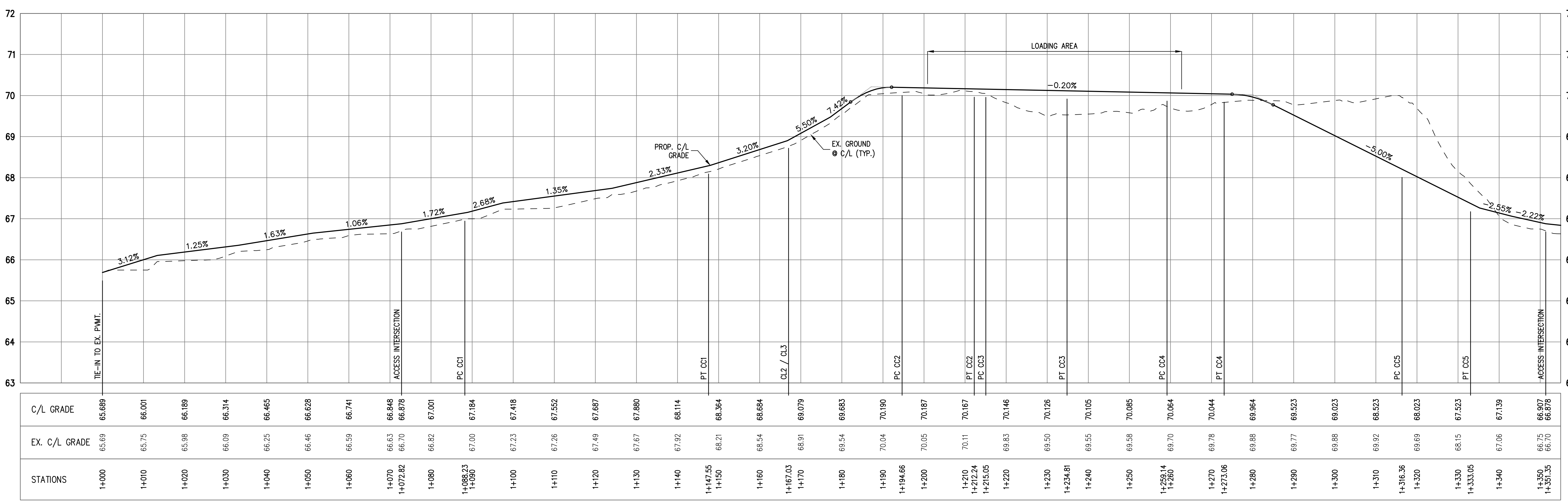

Suite 303, 375 West 5th Avenue
 Vancouver, BC, Canada V5Y 1J6
 e-mail: rna@milkovicharchitects.com
 web: www.milkovicharchitects.com

CoreGroup
 CONSULTANTS
 LAND DEVELOPMENT SERVICES
 320-8888 FRASERTON COURT
 BURNABY, BC V5U 5H8
 tel. (604)299-0605 fax. (604)299-0629

ISSUED FOR DEVELOPMENT PERMIT
 2019/10/10

revisions
 © Copyright reserved. This plan and design is and all times remains the exclusive property of Milkovich Architects Inc. and cannot be used without the architect's consent.
 All measurements must be checked on the drawings by the contractor.
 This drawing is not to be used for construction purposes unless counter-signed.

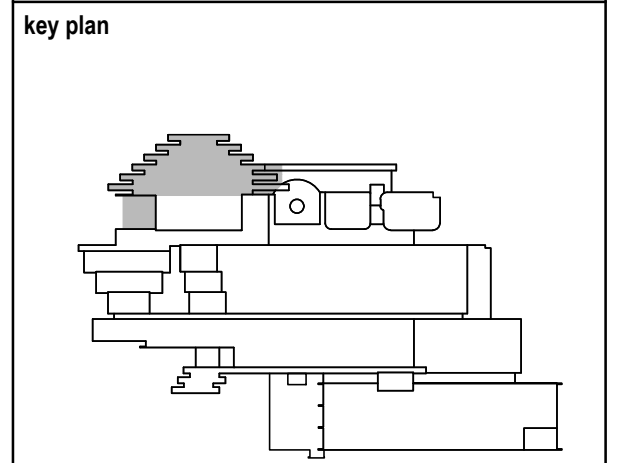

project title
MUSEUM OF ANTHROPOLOGY
GREAT HALL SEISMIC UPGRADE TP 1
 6393 NW MARINE DRIVE
 VANCOUVER, B.C.

drawing title
UBC MUSEUM OF ANTHROPOLOGY
CONSTRUCTION ACCESS
PLAN / PROFILE

drawn	BC	north arrow	
checked	CN		
scale	1 : 500		
drawing date	2019/09/18	printed	2019/10/10
project no.		drawing no.	3 of 5

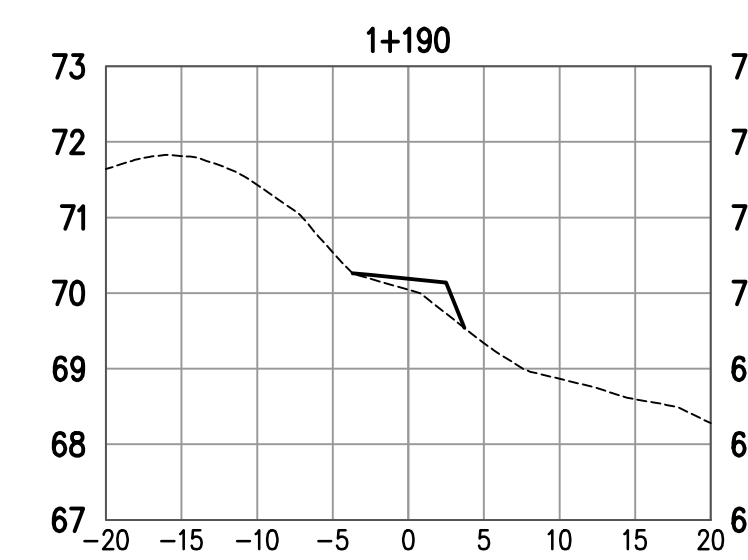
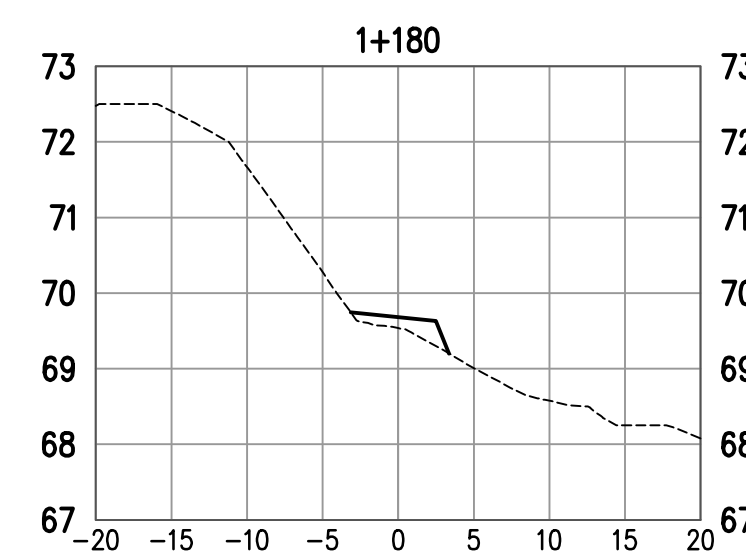
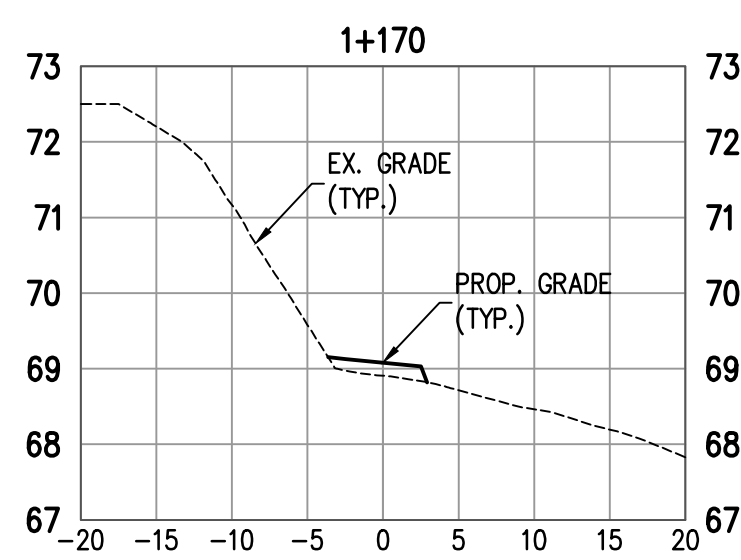
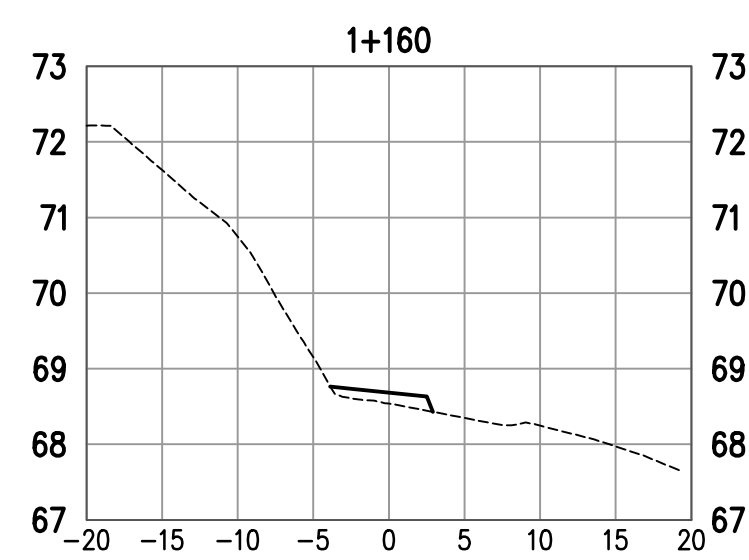
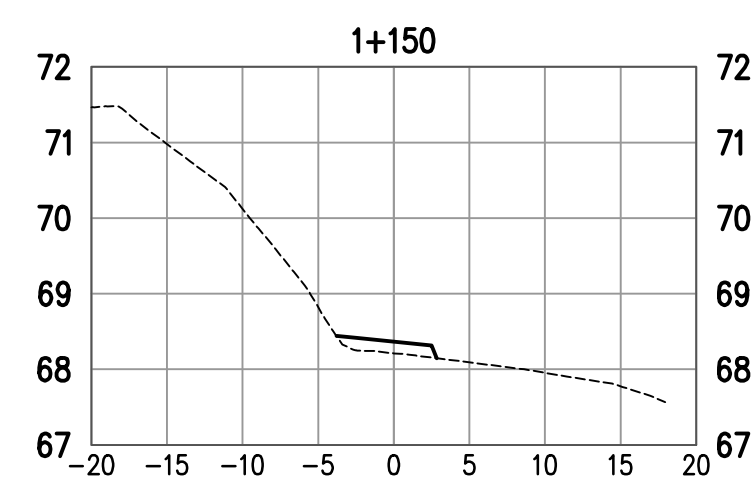
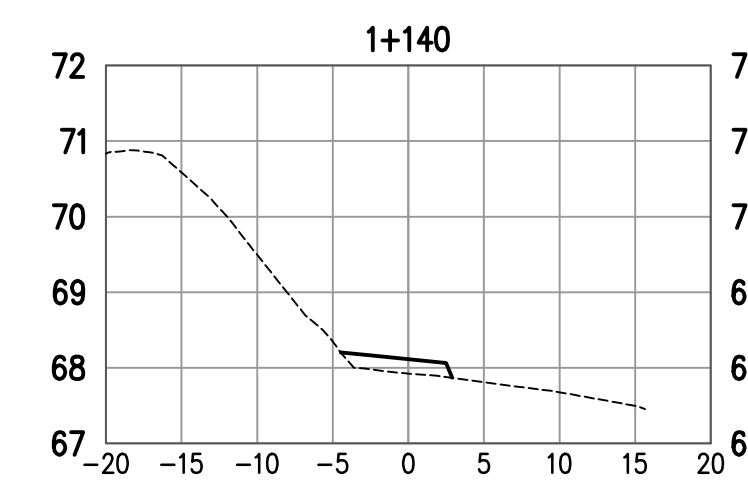
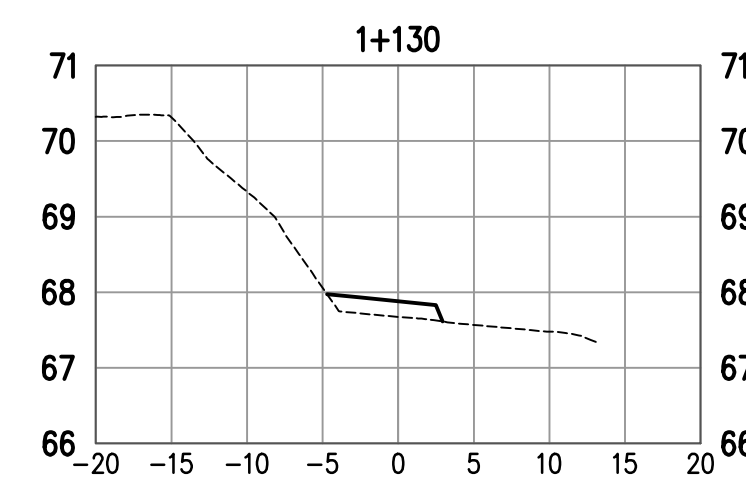
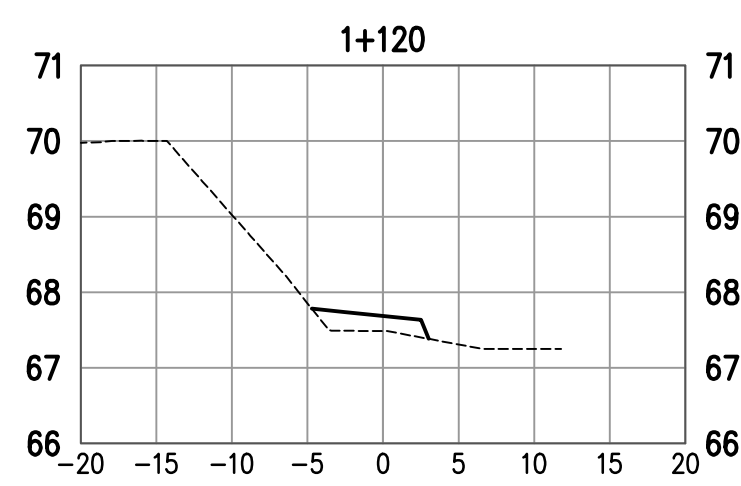
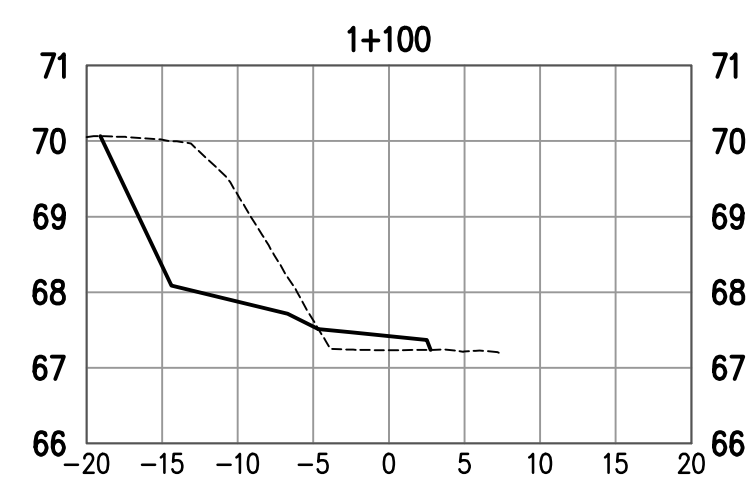
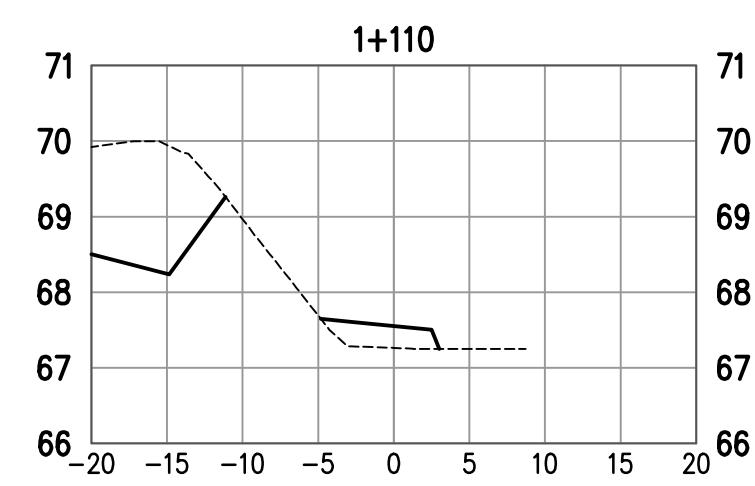
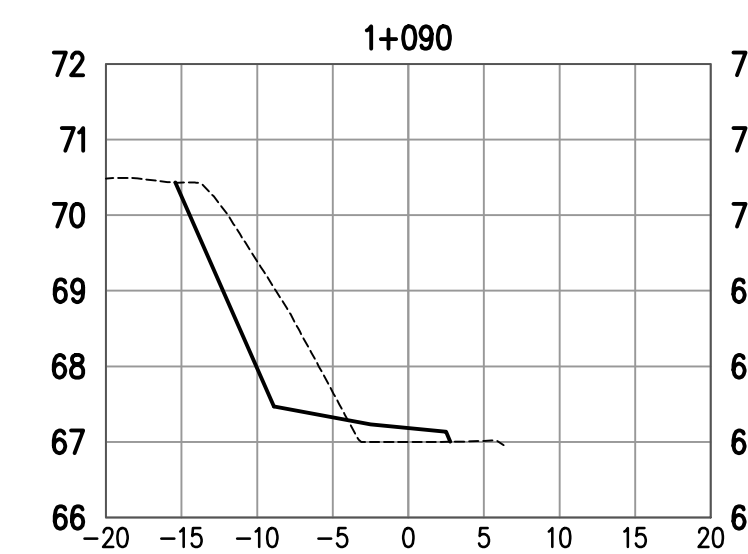
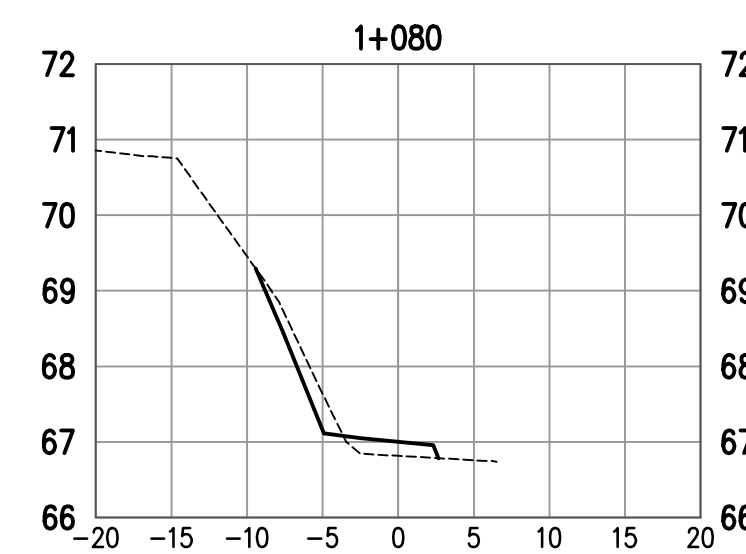
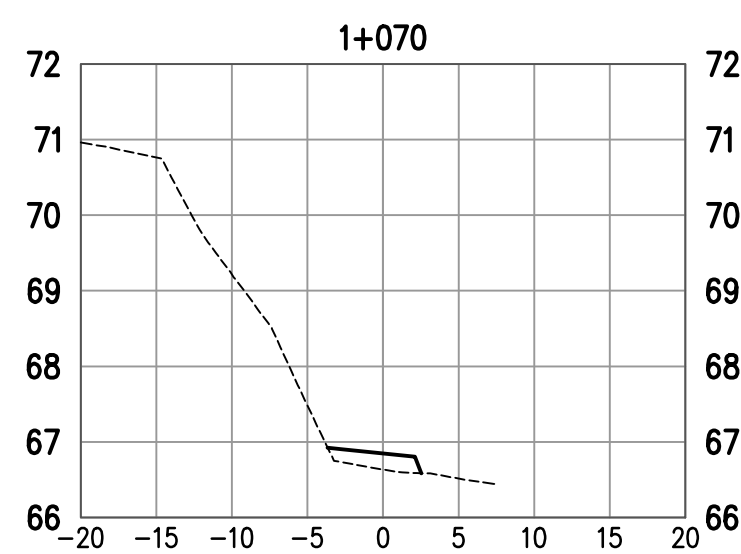
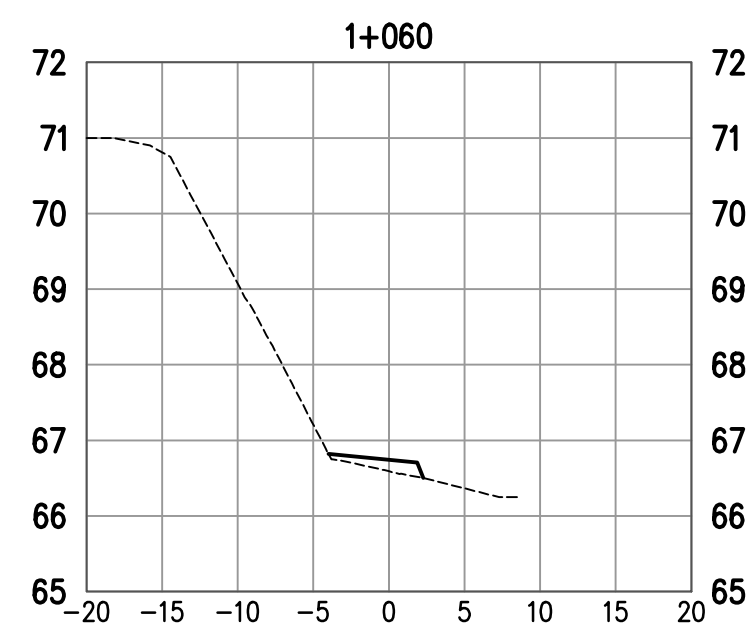
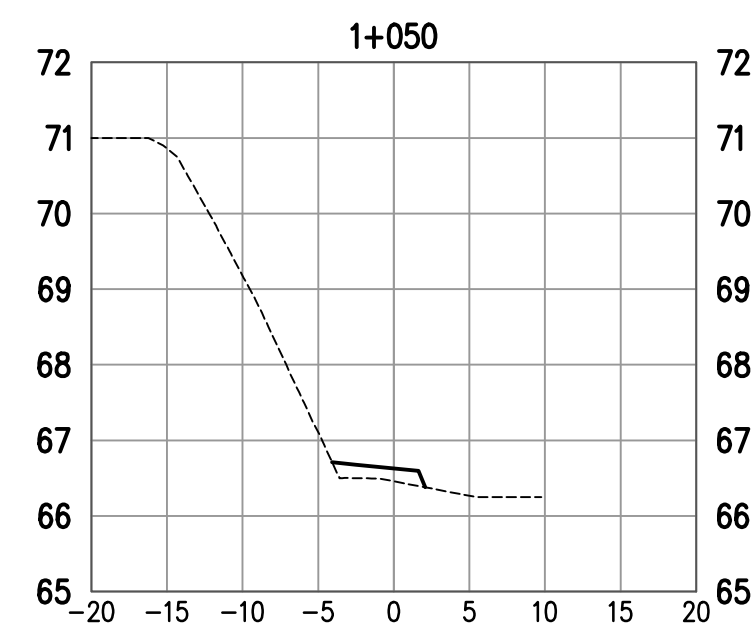
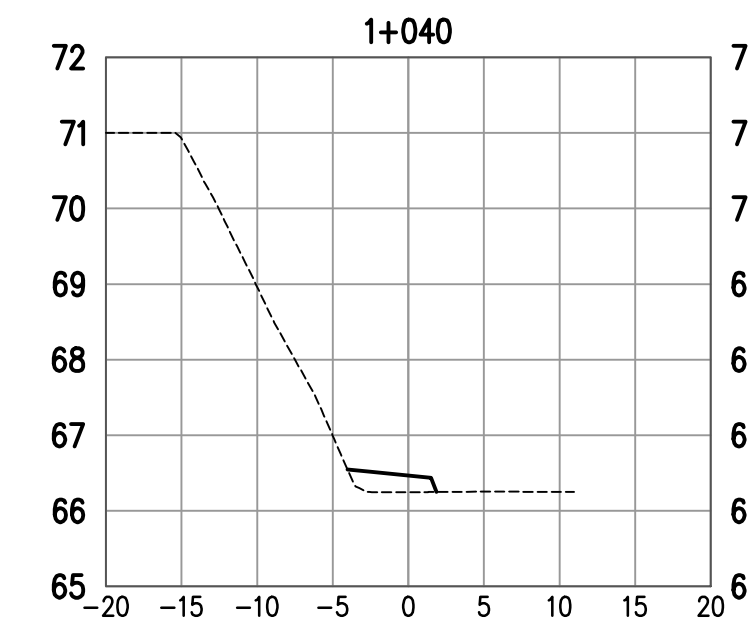
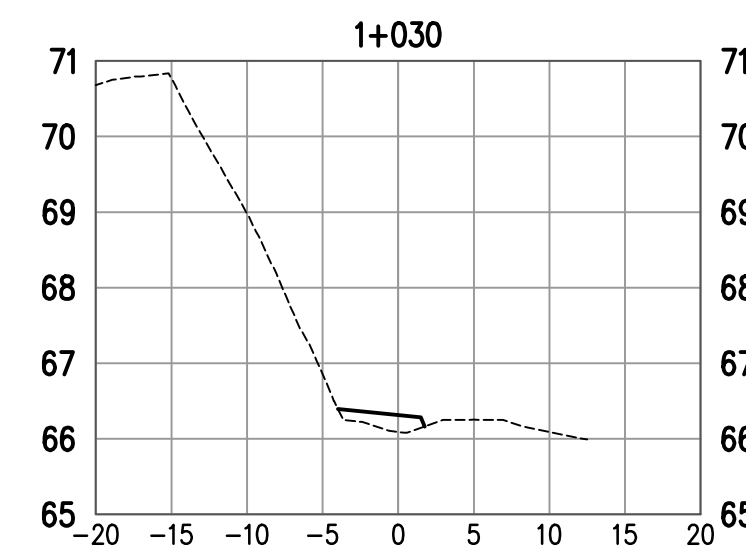
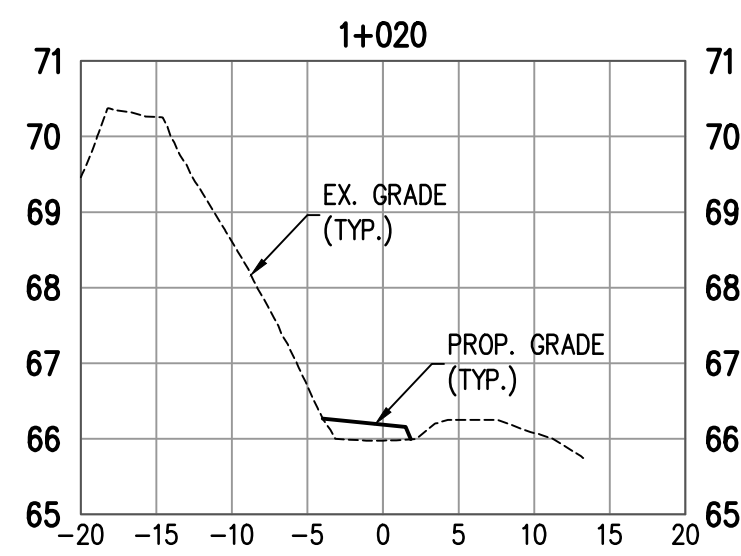
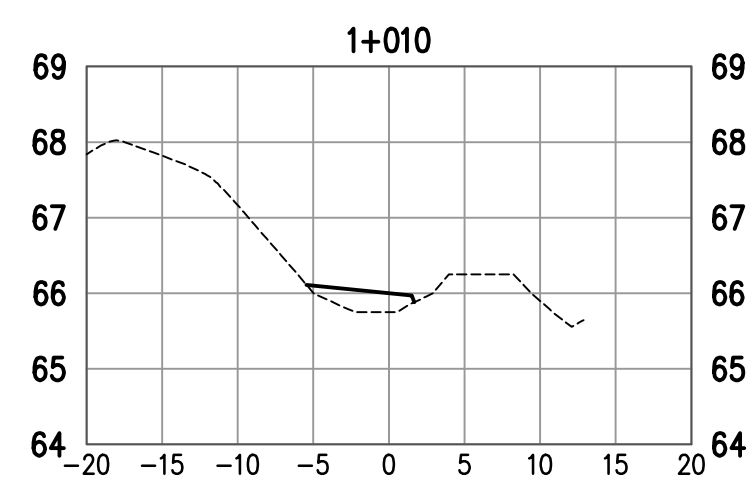
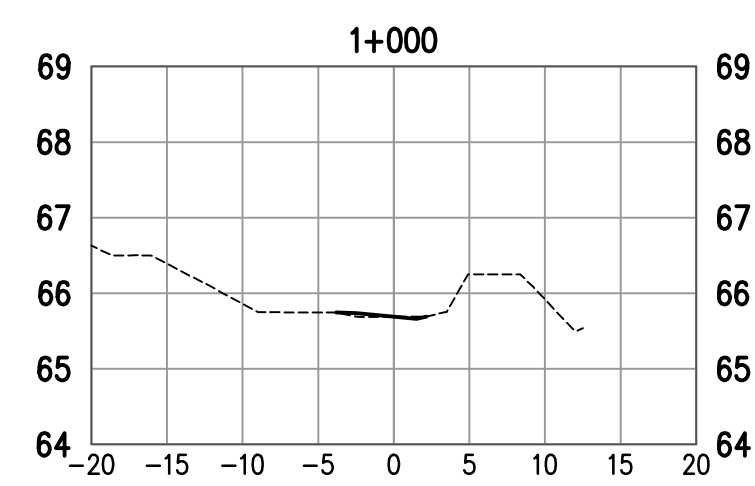

GENERAL NOTES:

1. CALL BC ONE-CALL 24 HOURS PRIOR TO CONSTRUCTION.
2. THESE DRAWINGS TO BE READ IN CONJUNCTION WITH OTHER CIVIL AND OTHER DISCIPLINE'S DRAWINGS.

Suite 303, 375 West 5th Avenue tel: 604.737.6061
 Vancouver, BC, Canada V5Y 1J6 fax: 604.737.6091
 e-mail: rma@milovicharchitects.com
 web: www.milovicharchitects.com

consultant

CoreGroup
 CONSULTANTS
 LAND DEVELOPMENT SERVICES
 320-8888 FRASERTON COURT
 BURNABY, BC V5J 5H8
 tel: (604)299-0605 fax: (604)299-0629

seal

issued

ISSUED FOR DEVELOPMENT PERMIT
 2019/10/10

revisions

© Copyright reserved. This plan and design is and all times remains the exclusive property of Nick Milovich Architects for and cannot be used without the architect's consent.

All measurements must be checked on the drawings by the contractor.
 This drawing is not to be used for construction purposes unless countersigned.

key plan

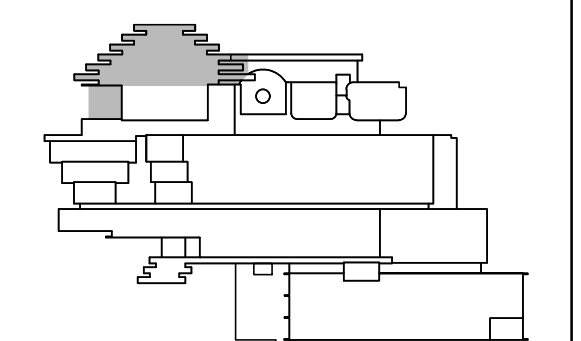

project title

MUSEUM OF ANTHROPOLOGY
 GREAT HALL SEISMIC UPGRADE TP 1
 6393 NW MARINE DRIVE
 VANCOUVER, B.C.

drawing title

UBC MUSEUM OF ANTHROPOLOGY
 CONSTRUCTION ACCESS
 CROSS SECTIONS

drawn	BC	north arrow	
checked	CN		
scale	1 : 500		
drawing date	2019/09/18	printed	2019/10/10
project no.		drawing no.	4 of 5
rev.			

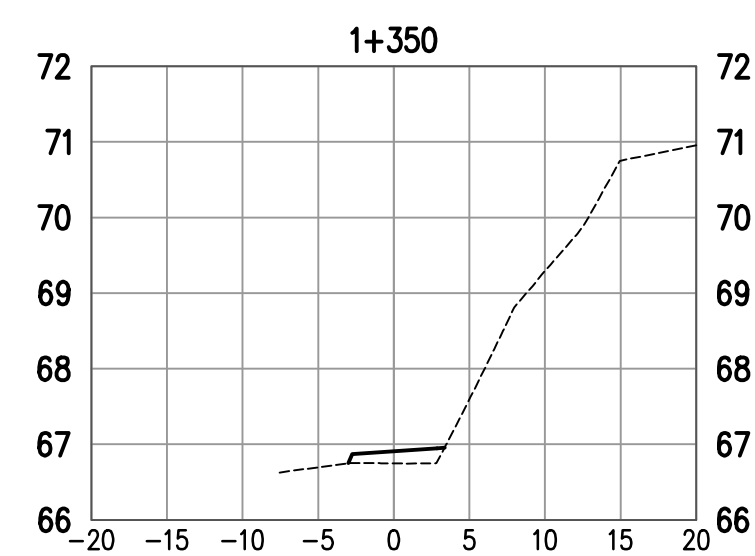
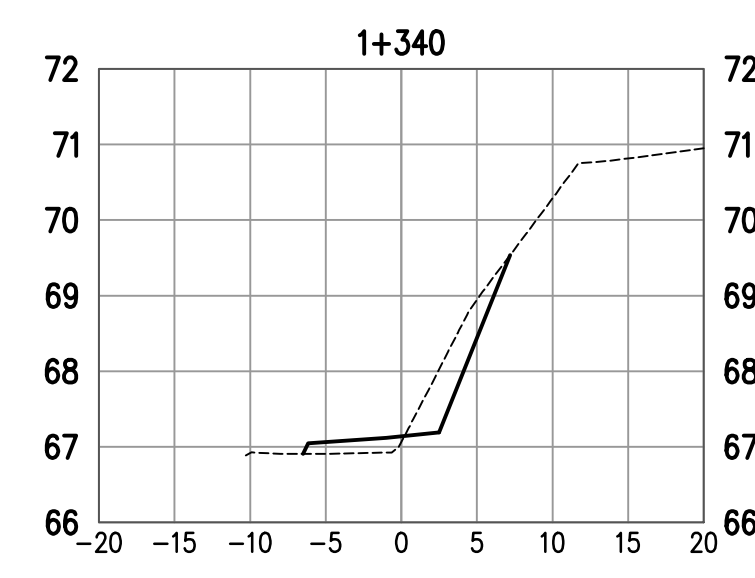
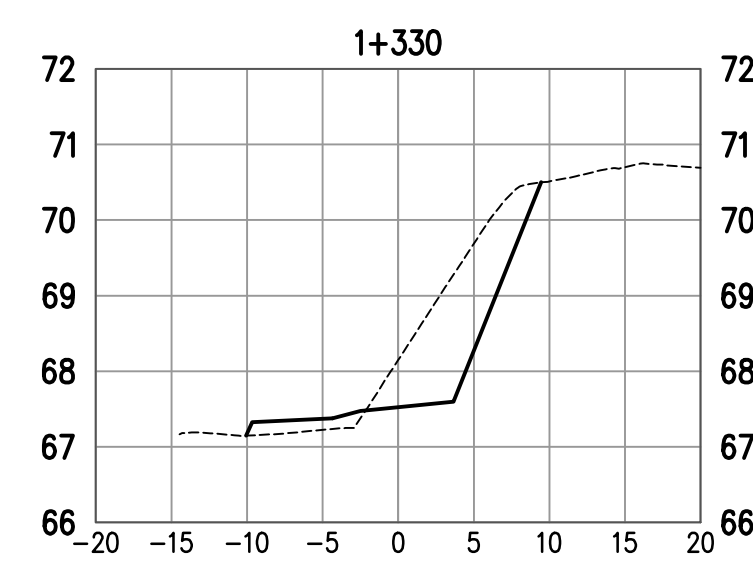
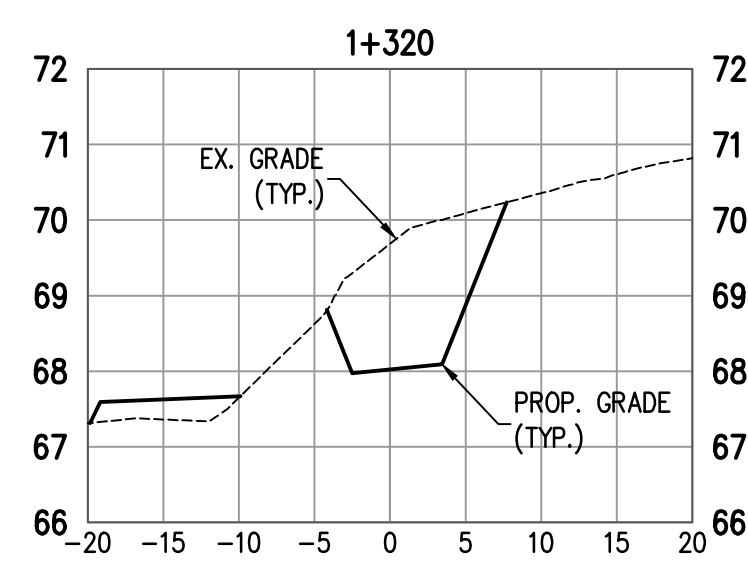
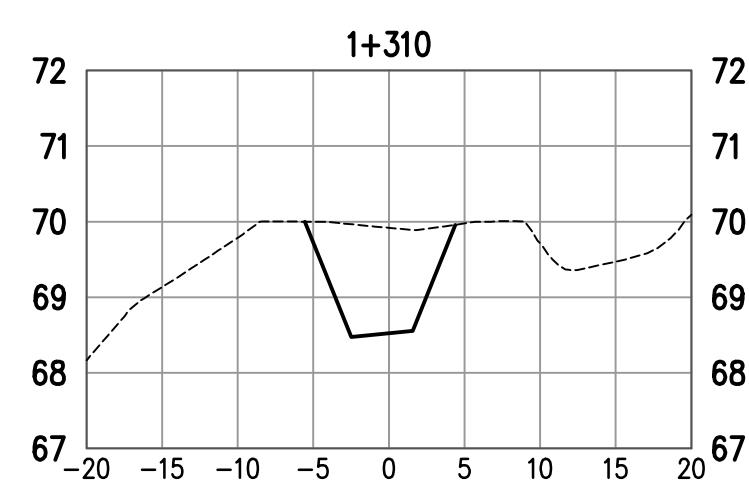
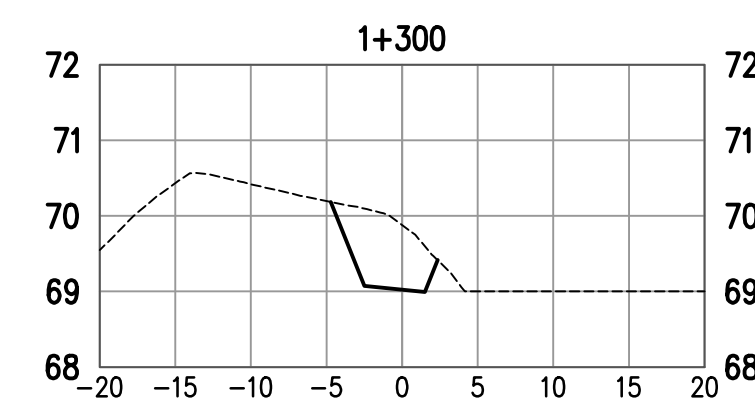
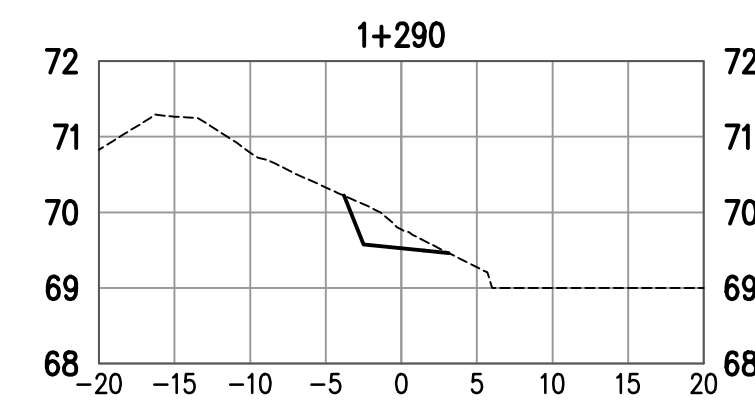
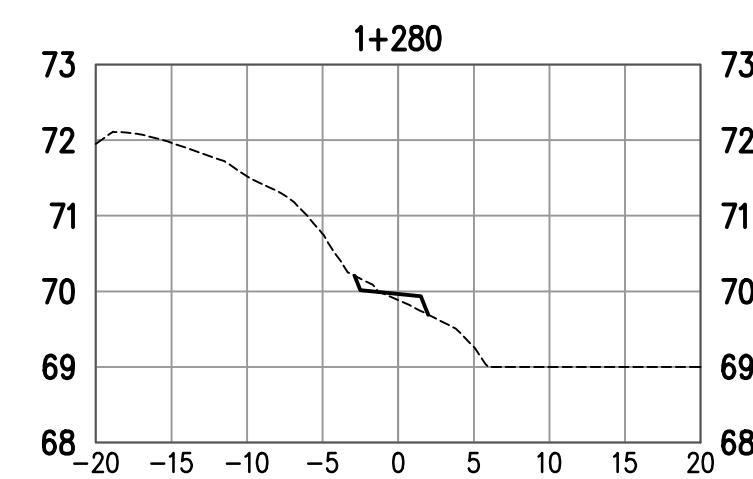
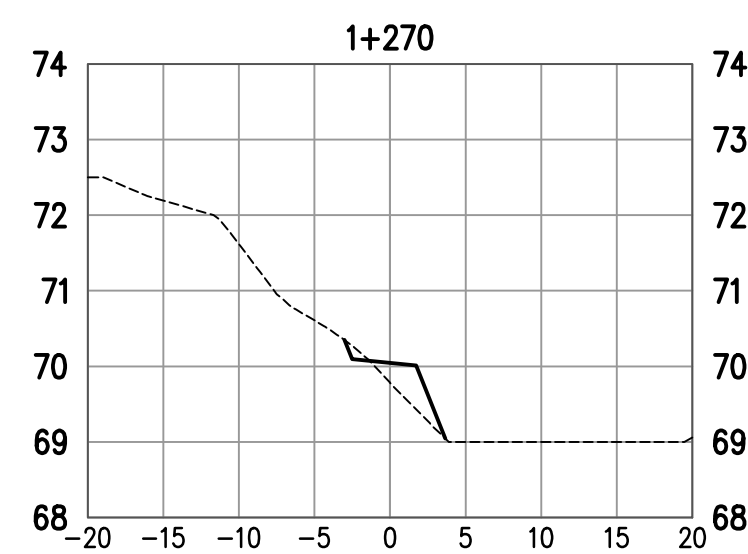
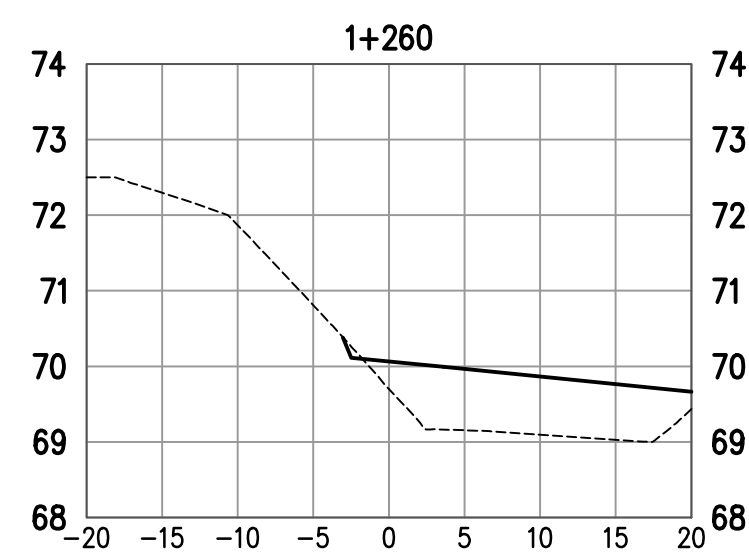
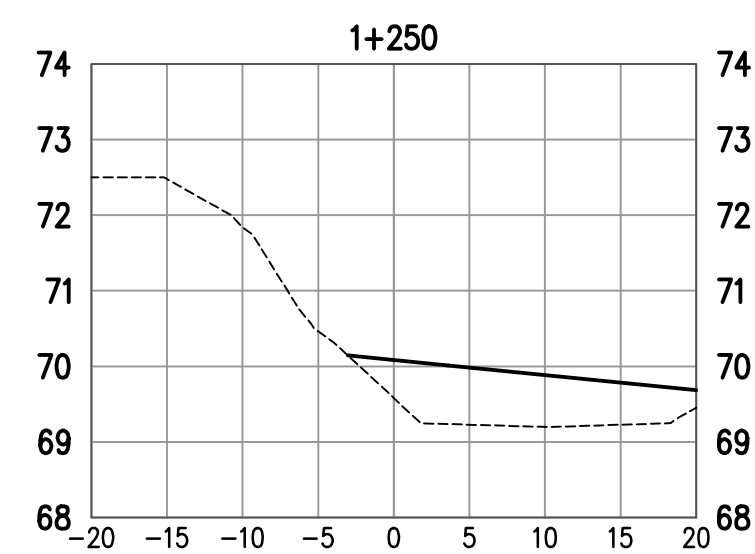
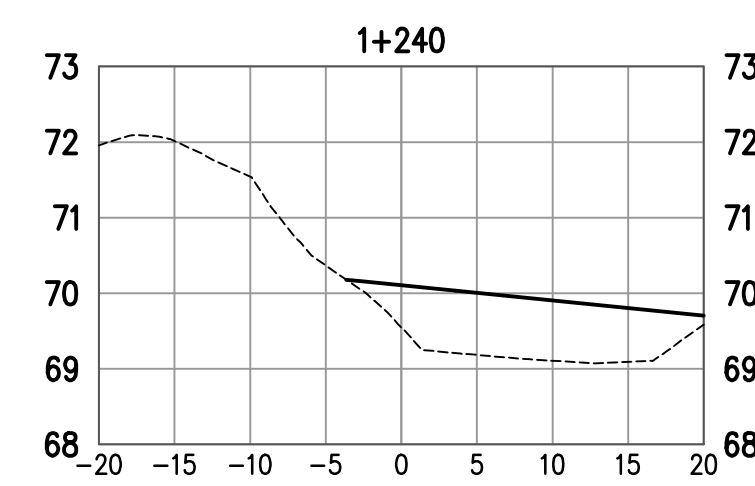
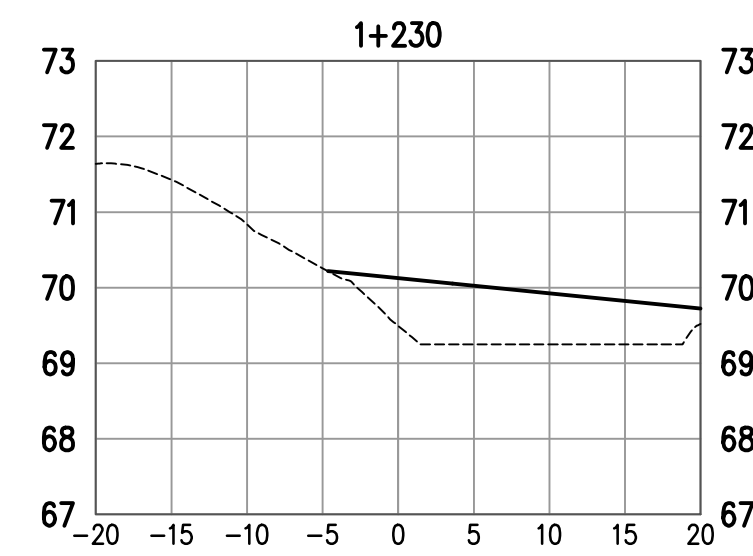
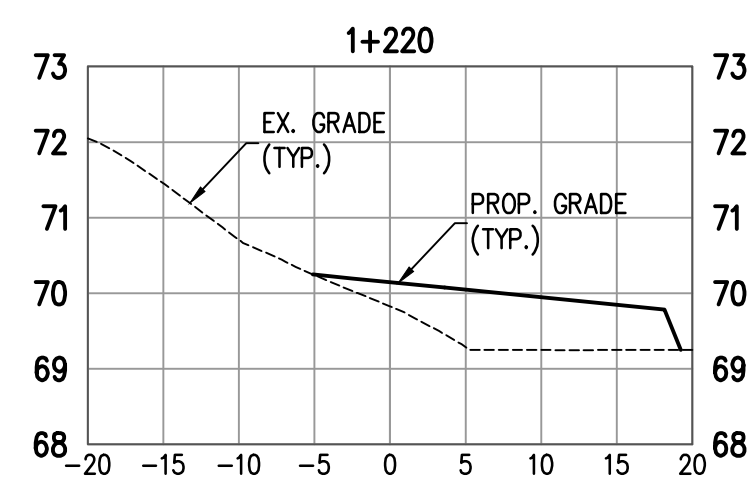
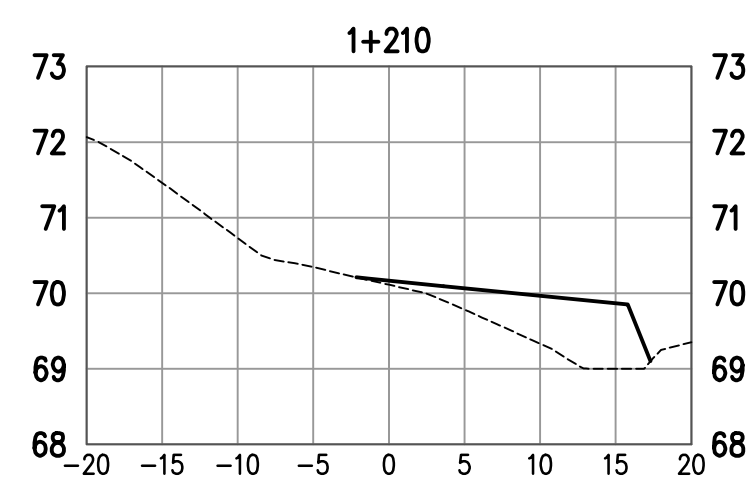
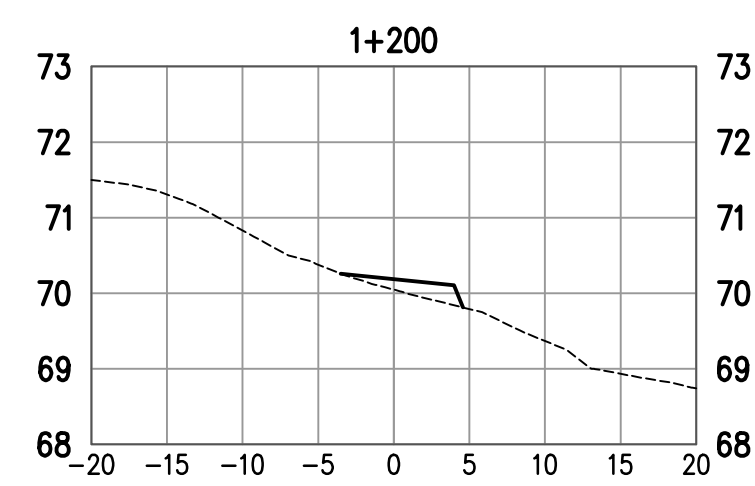

GENERAL NOTES:

1. CALL BC ONE-CALL 24 HOURS PRIOR TO CONSTRUCTION.
2. THESE DRAWINGS TO BE READ IN CONJUNCTION WITH OTHER CIVIL AND OTHER DISCIPLINE'S DRAWINGS.

Suite 303, 375 West 5th Avenue tel: 604.737.6061
 Vancouver, BC, Canada V5Y 1J6 fax: 604.737.6091
 e-mail: rma@milovicharchitects.com
 web: www.milovicharchitects.com

consultant

CoreGroup
 CONSULTANTS
 LAND DEVELOPMENT SERVICES
 320-8888 FRASERTON COURT
 BURNABY, BC V5J 5H8
 tel: (604)299 0605 fax: (604)299 0629

seal

ISSUED FOR DEVELOPMENT PERMIT
 2019/10/10

revisions
 © Copyright reserved. This plan and design is and all times remains the exclusive property of Nick Milovich Architects for and cannot be used without the architect's consent.
 All measurements must be checked on the drawings by the contractor.
 This drawing is not to be used for construction purposes unless countersigned.

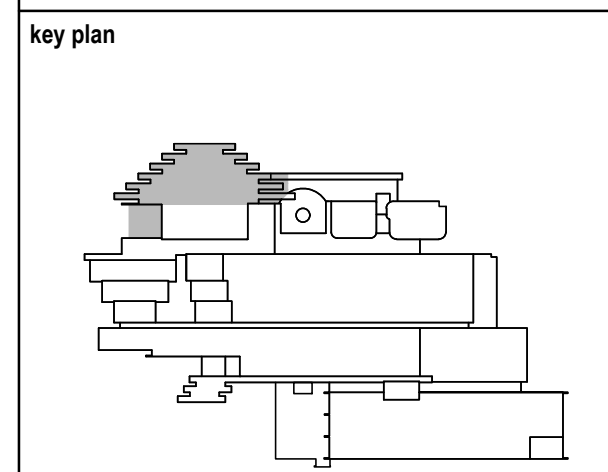

project title
 MUSEUM OF ANTHROPOLOGY
 GREAT HALL SEISMIC UPGRADE TP 1
 6393 NW MARINE DRIVE
 VANCOUVER, B.C.

drawing title
 UBC MUSEUM OF ANTHROPOLOGY
 CONSTRUCTION ACCESS
 CROSS SECTIONS

drawn	BC	north arrow
checked	CN	
scale	1 : 500	
drawing date	2019/09/18	printed 2019/10/10
project no.		drawing no. 5 of 5
rev.		